



## Safety Warnings



Always wear safety glasses when operating this torque meter.



Always use the proper range transducer for the application. Over torque may result in damage to the transducer or breakage resulting in personal injury. Under torque may result in an incorrectly tightened fastener that could loosen resulting in failure at a later date.



Do not use a transducer if it has been over-torqued.



Never apply torque in a situation where tool breakage may result in a fall or slip resulting in personal injury. Pulling on the wrench, as opposed to pushing on the wrench may help avoid this situation.



Always replace worn or rounded fasteners prior to applying torque. Slippage may occur resulting in personal injury.



Never try to recharge a non rechargeable battery.



Never mount a transducer to a bench that is unstable or will tip when a torque is applied.



Never use a torque transducer with an impact wrench.

## **Introduction**

The FUTEK Electronic Torque/Force Meter is a highly accurate torque/force analyzer and production tool. Use it as a high end torque calibrator or bring it to the work site to accurately apply torque to fasteners.

With the FUTEK Electronic Torque Meter you only have to buy one electronic module. Simply add ranges as you need them by purchasing additional torque transducers.

This Meter uses the very latest in computer technology including a small microchip installed on each transducer for true “plug and play” recognition of the attached torque sensor. Simply attach the transducer, turn the unit on and you are ready to go to work.

A full compliment of modes and functions combined with an easy to use interface make this torque meter the perfect device for all torque applications.

There are some very special features inside of this meter that distinguish it from the competition. For example, there is a “first peak” mode that allows you to test and calibrate micrometer (clicking) type torque wrenches. However, just having this software mode is not enough, you must also have circuitry that is fast enough to capture the fast “click” of a torque wrench or the ultra fast torque peaks of DC tools and pulse tools when in peak mode (always use a joint rate simulator when testing power tools, joint rate simulators simulate the application with springs).

The sampling rate of this torque meter is over 8,000 samples per second rivaling any torque data acquisition system.

Memory for up to 1350 torque data combined with a direct rs232c com port make this small unit a powerful data acquisition system.

Additionally, the torque meter has an industry leading triple 4 digit numeric display that shows you the limits settings at all times and prompts you with information during set-up.

These features combines with many other useful functions will make this the last electronic torque meter you will ever need!

# Table of Contents

Feature Overview....4

Keypad functions.....5

## General Operation

Suggested **mounting** positions....6

### Quick Start....7

To change the **mode** of operation....7

To change the **units** of measure....7

To turn **limits** on/off....7

To set a new **target torque** when % is the default....8

To **recall** the last cleared torque....8

To **save** a torque value to memory....8

To view the attached **transducer information**....8

## Menu Functions

To enter the **menu mode**....9

To **recall memory**....9

To **send memory** to a printer or computer....10

To **erase memory**....10

To **set filters**....10

To change the % **tolerance value**....11

To make **high low limits** the default tolerance method....11

To change the **display clear (reset)** method....12

Entering the limits value....12

**Power Standby Mode**....12

**Entering Numbers**....13

**Zeroing the Display**....13

**Torque Sensors (transducers) and Overload**....14

**Transducer Mounting Positions**....15

**Checking for Accuracy**....16

**Calibrating and bypassing the smart transducer calibration data**....18

**Selecting Custom Transducers**....20

**Printing and Sending Data**....20

**Battery and Power**....21

**Specifications**....22

# Features

User Friendly LCD with Industry leading triple numeric display

Software selectable filters

Three reset modes:  
Auto  
Manual  
Timed

Super large 5/8 high digits

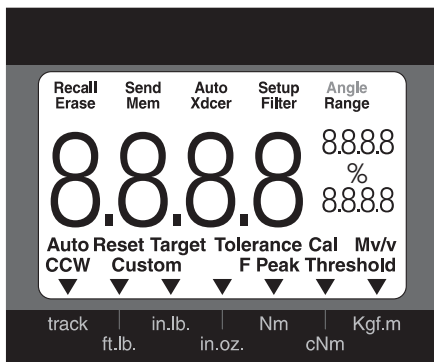

Hi/Low or % tolerance shown at all times

Track Peak and First peak mode

Memory for up to 1350 torque data.

Custom transducer mode allows easy adaptation to third party transducers

Auto convert engineering units

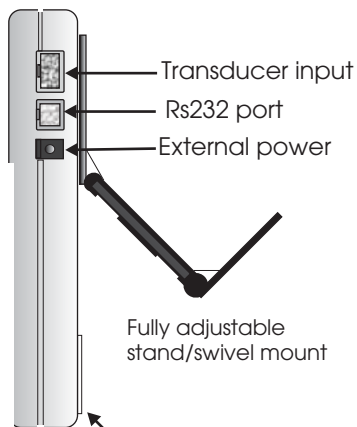
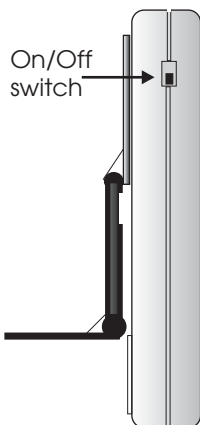

High impact plastic case with sealed membrane keypad

Easy access 9 volt battery compartment

# Keypad Functions

hold to change



Press once to turn limits on or off  
Press and hold to set new limits



Press to change modes  
(press save key to save new mode)



Recall last cleared torque  
Press and hold to send data on display  
to computer or printer



Press to view current torque in other units



Increases value of blinking digit  
when setting numbers.



Selects next digit when setting numbers  
Selects next function when in Menu mode.  
Scrolls through data in memory when recalling memory



Clears data  
on display



Saves data on display or  
Selects the current function  
when in menu mode

hold to change

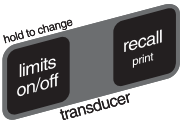

Press together to view the attached  
transducer data

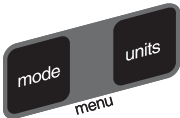

Press together to enter menu (set-up) mode



Press together to zero the meter

**Suggested mounting positions**  
**Loosen the 4 locking screws prior to adjusting**



Over a ledge

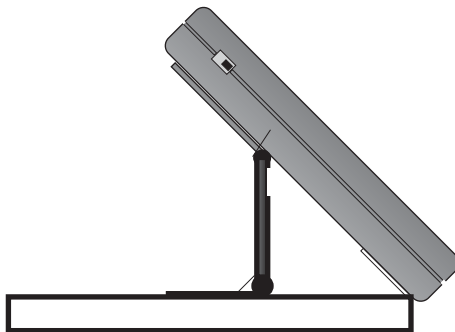

Typical bench mounting

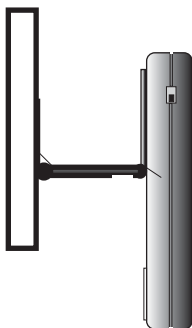

Vertical wall

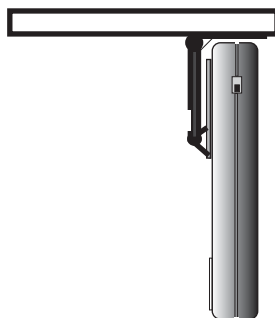

Under a shelf



Reverse bracket and hang on a thin shelf



Belt mount

# General Operation

## Quick Start:

1. Turn off the power.
  2. Plug in the proper range transducer- Turn on-wait for the display to show zero (do not apply torque during this time). The meter reads the transducer smart chip when turned on.
  3. Apply torque, (see warnings) you will see the reading increase as you increase the torque.
  4. Clear the display with the clear key.
- Or
5. Save torque to memory with the save key.

## To change the mode of operation

1. Press the mode key until “peak”, “track” or “fpeak” shows.
2. Press the save key to accept the new mode.

**Track** mode displays the torque as it increases and decreases.

**Peak** mode tracks up but will hold on the peak value.

**Fpeak** (first peak) mode will capture the click point of a micrometer torque wrench and disregard further input. This mode is used to test and calibrate click type torque wrenches.

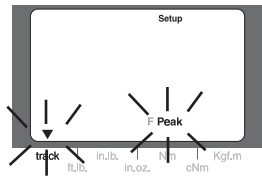

## To change the units of measure

1. Press the units key until the arrow points to the desired units (the set-up icon will also be on). (EEEE will show if units are out of range for the transducer attached).

2. Press the save key to select the new units of measure.

**Note:** When you change the units of measure the limits values (target or high and low) will be re-set to zero.

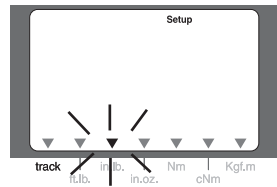

## To turn limits on/off

1. Press limits key once to turn on.
2. Press the limits key again to turn off.

### Note:

You will see the limits value in the secondary set of digits- “%” and the current target torque will show if % is the default or high and low arrows with the actual high and low values if the high and low method of limits is selected (see menu functions below to select the different methods).

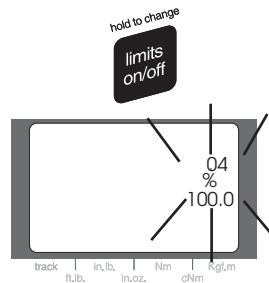

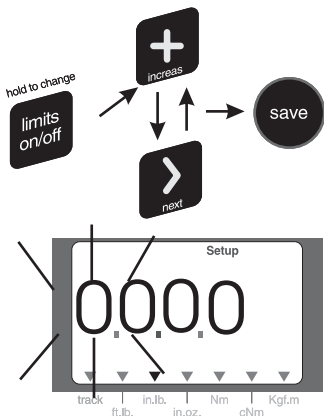

### To set a new target torque

(When % is the default limits mode)

1. Press and hold the limits key for 1 second. (The current target torque shows with the first digit blinking).
2. Use the increase and next key(s) to set the new target torque (see “entering numbers” below).
3. Press the save key to accept the new target torque.

**Note:**  
You will see the new target torque displayed in the secondary set of digits when the limits mode is on. This value will remain, even after turning the unit off, until you either change the units of measure or plug in a new transducer.

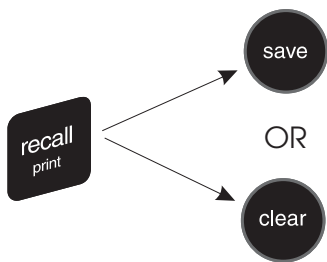

### To recall the last cleared torque value

1. Press the recall key.
2. Press the clear key when finished viewing and return to operation.

**Note:**  
You can press the save key to save the recalled torque value before pressing the clear key. This allows you to recall and save a value that may have been accidentally cleared prior to saving.



### To save a torque value to memory

1. Press the save key to save the displayed torque value to memory.

**Note:** If you press the save key when zero is displayed you will store the zero value in memory.

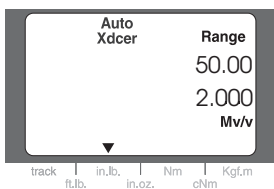
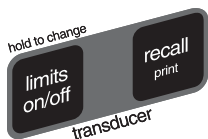

### To view the attached transducer information

1. Press the transducer keys.
2. Press clear when finished viewing the data.

**Note:**  
The range is in the upper right digits.

The MV/v (cal factor) is in the lower digits.  
 Smart Transducers will show “Auto Xducer”

### Menu functions:

1. Activate the menu function by pressing the mode and units key at the same time (the display will show set-up).
2. Press the next key to step through the various options. Press the save key to select the option that is displayed.

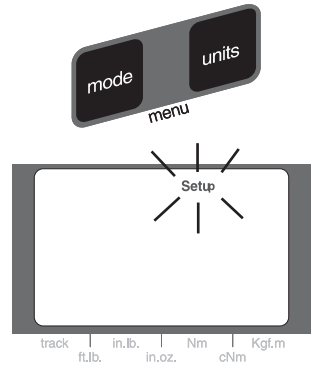

### To recall memory

1. Press menu keys (set-up icon comes on).
2. Press the next key once or until the "recall mem" icon is on (if you miss keep pushing the next key until "recall mem" shows).
3. Press save to select (SEL) the recall memory option. The number of data in memory now shows.
4. Press the next key to view the data (press the increase key to view the previous torque data).
5. Press the clear key when finished.

Note: The data number is shown in the upper right digits.

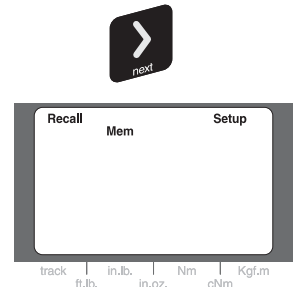

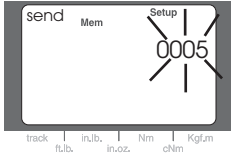

### To Send Memory to a printer or computer

1. Attach the torque meter serial communication cable to your printer or computer com port. (set the baud rate to 4800,8,n,1,hardware). refer to your computer manual for details on how to communicate with serial devices.
2. Press the menu keys.
3. Press the next key twice or until the display shows send memory.
4. Press the save key to select the send memory option.

5. The data in memory will now be sent (the data number will count down as the data is sent out the serial port.

See “printing and sending data” later in this manual for more information.

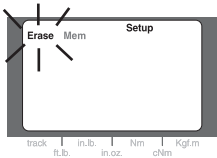

### To Erase Memory

1. Press the menu keys.
2. Press the next key three times or until the “Erase mem” icon shows.
3. Press the save key to select the erase memory function (the display will blink giving you a second chance to decide if you really want to erase memory).
4. Press the save key again to confirm and erase the memory or clear to exit without erasing memory.



Exit without erasing  
or



Erase Memory



### To Set filters (500hz is common for hand tool operations)

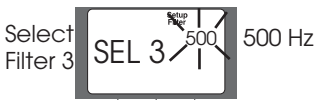

1. Press the menu keys.
2. Press the next key four times or until “filter” is shown.
3. Press the save key to select the filter function.
4. Press the next key until the desired filter is shown.
5. Press the save key to store the new filter setting.

Note:

The standard filter setting is 500 Hz for hand type applications and 1500 Hz for power tool

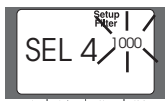

applications. Filters are used to “screen” out any non-torque noise or vibration that may be input from a high speed power tool. Use a lower filter setting if you are getting occasional spikes in the reading.

### To change the % tolerance value from the current setting

1. Press the menu keys.
2. Press the next key 5 times or until “tolerance” shows.
3. Press the save key to select the tolerance function.
4. Press the next key until “% On” shows.
5. Press the save key.
6. Enter the new % value (01-99%) with the increase and next keys (see “entering numbers” below).
7. Press the save key when the value is correct.

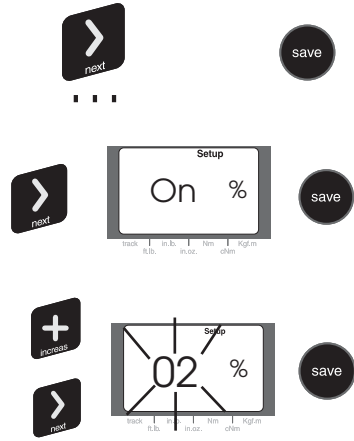

### To make high/low limits the default tolerance mode

1. Press the menu keys.
2. Press the next key 5 times or until “tolerance” shows.
3. Press the save key to select the tolerance function.
4. Press the next key until the high/low arrows show.
5. Press the save key to store the new tolerance setting.

Note:

Once you change the tolerance mode it will

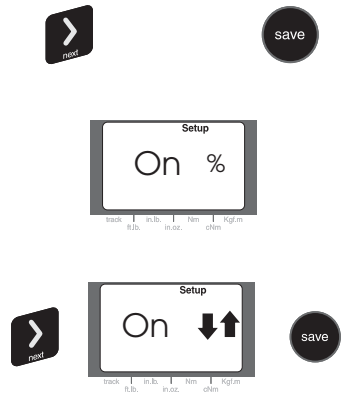



AUto...OFF...1sec.....9sec

hold to change



hold to change



become the new default tolerance mode each time the torque meter is turned on.

Now when you set the limits (press and hold the limits on/off key) you will be prompted to set the high and low limits instead of the target torque.

### To change the display clear method

1. Press the menu keys.
2. Press the next key 6 times or until the “Auto Reset” icon shows.
3. Press the save key to select the Auto Reset function.
4. Press the next key until:
  - “AUt0” shows (Auto sense)
  - “Off” (manual clear using the clear key)
  - “1.....9” (seconds before the display clears itself)
5. Press the save key to store new setting.

Note:

If auto sense is selected the torque meter will automatically clear the display when a new torque cycle begins. This means that you do not have to continually reach up and clear the display manually.

### Entering the limits (tolerance) settings.

1. From the operation mode press and hold the limits on/off key.

If you have set the % function set then the meter will prompt you to enter the target tolerance (it will automatically calculate the limits).

If you have the high/low function set then the meter will first prompt you to enter the low limit and then the high limit.

### Power saving standby mode

When the torque meter has not been used for approximately 3 minutes it will go into the power

down or “standby” mode. The display will show “. . .”.

Press the clear key to get back to normal operation. For the longest life from the batteries turn the meter off when not used.

**Entering Numbers**

When a number needs to be entered, a default value (or the last value entered) will be shown. The digit that can be changed will blink.

Press the increase key to increase the value of the blinking digit.

Press the next key to go to the next digit.

Press the increase key to increase the value of the next blinking digit.

Repeat for digits 3 and 4.

When the number is correct, press the save key to save the new value.

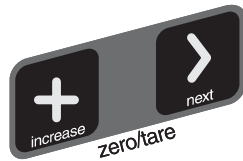
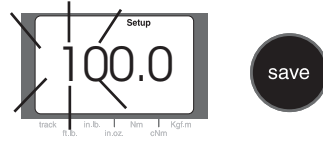
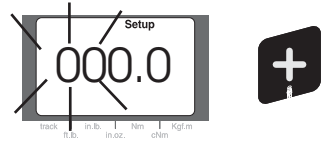

**Zeroing the display**

If you press the increase and next keys at the same time you will “Zero” the unit. Make sure that there is no load on the transducer when pressing the zero keys. The meter will not read torque until approximately 2% of the transducer range has been reached, therefore you must zero the unit even when the display shows zero.

**IMPORTANT!**

Always zero the unit when changing direction. If you plan to use the meter in the counterclockwise direction load the transducer three times in the counterclockwise direction (to

full scale) and then zero the display. Press the zero keys even if the display shows “000.0” This will compensate for small amounts of hysteresis (hysteresis is a natural characteristic of steel).

### Torque Sensors and OVERLOAD

Torque transducers are designed to give years of reliable operation if treated properly. Torque transducers are sensitive electro-mechanical measurement devices and should be handled with care.

Never over-torque a transducer beyond its usable range. It is good practice, when possible, to select a transducer that is at least 25% greater in range than the expected torque it will apply. This may help avoid accidental over-torque.

The torque transducers that are supplied with the torque meter will accept up to 50% over torque without damage. However, if this should occur we recommend that you return the unit for a calibration check.

The torque meter has an audible warning system that will alert you if you have exceeded the usable range of the transducer. A constant beeping sound will occur.

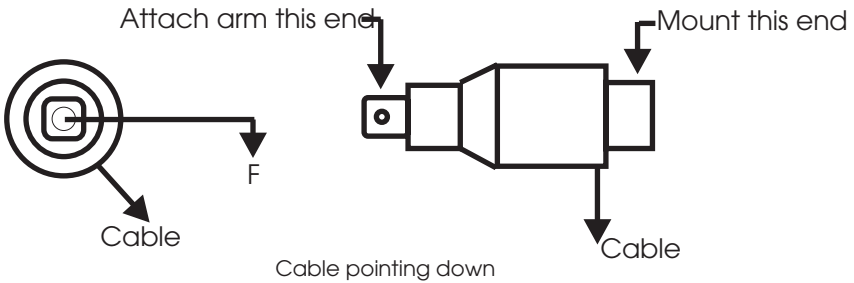

Correct position for testing torque extensions

## Transducer mounting positions for bench top style torque transducers:

### Warning!

Always make sure the bench is strong enough and will not tip when applying torque. Bolting the bench to the ground may be necessary on higher range transducers.

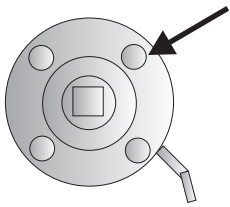
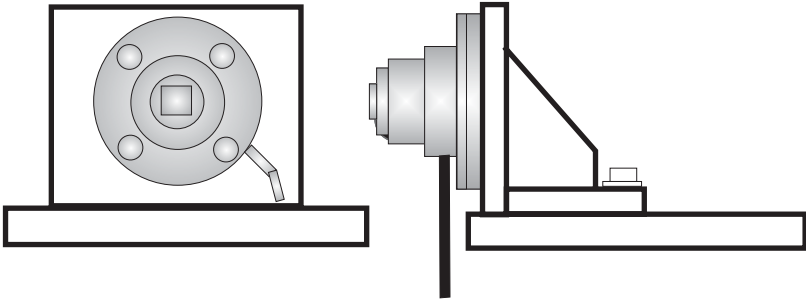

3" bolt circle for 3/8 inch screws  
or  
2.175" bolt circle for 1/4 inch screws

Make sure the cable is pointing down (4 O'CLOCK POSITION) when mounted on a bench. This will place the primary axis in the correct position.

Stop applying torque when you hear this sound, and press the clear key to stop the buzzing.

## **Checking for accuracy**

The Torque Meter and torque transducers are factory calibrated and should be checked on a regular basis. We recommend that, provided the transducers are used according to this manual, they be re-certified yearly. Since the frequency of use, among other factors, may affect the calibration, the user must determine the best calibration interval.

It is important to use the correct arm length since arms that are too short may create excessive bending loads.

### **Recommended torque arm lengths:**

4" 100 in lb

10" 250 in lb and 50 ft. lb.

24" 150 and 250 ft.lb.

48" 500 ft. lb.

These arm lengths closely represent the length of typical wrenches that will be used on the transducers. They also allow for no more than 150 lbs of weights, which also represents the "typical" amount of force required to generate the torque with a wrench. Do not use a 10" arm to calibrate a 250 ft. lb. wrench. This would require 300 lbs of weights, this is not good for the transducer and is not representative of the typical weight needed to generate 250 ft.lb. applied by a person. Most conventional torque wrenches are designed to be long enough to allow a 150-175 lb person to generate the force required to generate the needed torque. Using the above arm lengths will be consistent with this philosophy.

The accuracy of the meter is such that any incorrect zero caused by out of balance arms, mis-alignment or sloppy adapters used on the torque arm system may cause a "perceived" out of tolerance situation. This can happen when you use a female drive torque arm on a female drive transducer and use a male-male adapter in between. It can also happen when you use an adapter to reduce a 1/2" female drive arm down to a 3/8" female drive using an off-the-shelf adapter. For this reason you must always use the proper drive arm with the transducer. If the transducer is a 1/2" female drive then you must use a 1/2" male drive torque arm.

Even benches that are not flat or deflect during high load calibrations are unacceptable. In this case the transducer will not be perpendicular with the

weights and this will show on the meter (yes the meter is that sensitive), resulting in a possible out of tolerance condition.

### **Procedure for checking accuracy**

Transducers are calibrated to within .5% (bench type) or 1% extension type IV +/- .1 at the factory. If you require greater accuracy you can bypass the smart chip in the transducer and perform a manual calibration on transducers. This will account for variations in torque arm calibration systems.

**IMPORTANT!**  
**YOU MUST ALWAYS DO THE FOLLOWING:**

**MOUNT THE TRANSDUCER SO THE CABLE IS POINTING DOWN.**

**PUT THE METER IN *TRACK* MODE.**

**1. NEVER USE A TORQUE ARM THAT IS NOT BALANCED ABOUT ZERO. A HIGH PRE-LOAD, OR AN OPPOSITE DIRECTION PRE-LOAD REDUCES ACCURACY AND IS NOT INDICATIVE OF REAL APPLICATIONS. A SLIGHT PRE-LOAD MAY, HOWEVER, BE NECESSARY TO TAKE UP DRIVE TOLERANCES IN THE DIRECTION TO BE TESTED. A 1 OR 2 LB HANGER WEIGHT SHOULD BE SUFFICIENT.**

**2. ALWAYS APPLY FULL SCALE TORQUE, THREE TIMES, WITH WEIGHTS, IN THE DIRECTION YOU ARE TESTING PRIOR TO RUNNING AN ACCURACY TEST.**

**3. AFTER STEP 2 ABOVE, WAIT AT LEAST 30 SECONDS OR FOR THE WEIGHT HANGER TO STABILIZE. SWINGING HANGERS WILL GIVE AN INCORRECT ZERO READING AND MAY THROW OFF ACCURACY.**

**4. AFTER STEP 3 ABOVE PRESS THE ZERO BUTTONS (*EVEN IF THE DISPLAY SHOWS "000.0"*) DO NOT PRESS THEM AGAIN UNTIL YOU START A COMPLETE NEW TEST CYCLE (STARTING FROM STEP 1 ABOVE).**

**5. AFTER STEP 4 ABOVE APPLY 10% LOAD, LET THE HANGER STABILIZE AND CHECK READING. DO NOT REMOVE THE WEIGHTS WHEN FINISHED CHECKING AT THIS POINT.**

**6. AFTER STEP 5 ABOVE APPLY ADDITIONAL WEIGHTS TO THE HANGER TO BRING THE TORQUE TO 50% OF LOAD AND CHECK READING. DO NOT REMOVE THE WEIGHTS WHEN FINISHED CHECKING AT THIS POINT.**

**7. AFTER STEP 6 ABOVE APPLY ADDITIONAL WEIGHTS TO THE HANGER TO BRING THE TORQUE TO 100% OF LOAD AND CHECK READING.**

**THE MAJORITY OF ACCURACY PROBLEMS OCCUR DUE TO INCORRECT LOADING SEQUENCE, ZERO PROCEDURES AND TORQUE ARMS THAT**

**ARE NOT IN BALANCE WITH A SLIGHT PRE-LOAD IN THE DIRECTION TO BE CHECKED.**

### **Calibrating the torque transducer:**

You can not change the information on the smart chip within the transducer. If the values on the chip need to be changed then one of two things MAY have happened:

1. The torque arm system, or the procedure, is introducing errors that when added are creating an out of tolerance situation (SEE ACCURACY CHECKING ABOVE)..
2. The transducer has been damaged and needs repair (usually shown by significant errors).

### **Bypassing the smart transducer feature.**

If you want to bypass the smart chip calibration data, and use the calibration data that you create with your torque arms, you can do so by assigning a “custom” transducer number to the transducer and manually calibrating it using your own dead weight system. This method stores the calibration data for the transducer in the memory of the meter, not in the memory chip inside the transducer. In order to use the custom transducer data you must select the custom transducer number when you power on the unit (see selecting custom transducers below). If you do not select the custom transducer number the meter will revert to the calibration data on the chip inside the transducer.

You can tell if the system is using the smart chip inside the transducer if, after pressing the transducer keys you see the words “auto Xducer”. You will see the words “custom” transducer if you have selected the transducer manually.

This method can be used to “fine tune” a transducer, possibly resulting in higher accuracy and can also be used for calibrating third party transducers to the torque meter.

### **To manually calibrate a “custom” transducer**

1. From normal operation mode press the menu buttons
2. Press the next key until the word “CAL” is displayed. Press the save key to select the cal option.

The current default custom transducer number (01 to 15), will show and flash (unless it is a smart transducer in which case you must press the next key to select a custom transducer number).

Press the next key until the desired custom transducer number is shown (mark this number on the transducer for future reference).

**Note:** The current transducer settings for the transducer number will show as you scroll through the transducers, all default values are “9999” or “1000” and 2.000 Mv/v.

Press the save key to select the desired transducer number.

The current full-scale range will now be displayed (will default to “9999” if this number has never been assigned) with the first number flashing (do not worry about the position of the decimal, that will be set next).

3. Press the increase and key to make the digits read the full-scale range of the transducer you are going to calibrate. Press the save key
4. Now set the decimal position with the next key (keep pressing until you see the

decimal point)..

Press the Save key.

5. Set the units by pressing the units key. Press Save.

6. Set the estimated clockwise (cw) Mv/v (if known, use 2.000 if not known). Press Save.

7. Set the Counterclockwise (ccw) Mv/v (if known, use 2.000 if not known). Press Save.

8. The display will now show “calc” (more on “calc” later). Press the next key until the unit shows “cert”. which means you are going to calibrate (certify) a transducer with dead weights.

The display will now show “CCW CAL0” This means it is ready to take a counterclockwise zero reading.

SEE ACCURACY CHECKING PROCEDURES FOR THE PROPER METHOD TO LOAD A TRANSDUCER.

9. Load the transducer, with a balanced arm and a slight pre-load, in the counter clockwise direction three times to full scale with dead weights, and remove the weights but not the arm and pre-load hanger. Wait 30 seconds or for the hanger to settle and press the Zero buttons (even if the display shows 000.0).

The Display will now show “CCW FS” which is prompting you to apply the **Full-Scale** weights to the arm in the counterclockwise direction.. Apply the full-scale weights in the counterclockwise direction, stabilize the weights and press the save key. Make the display read the full-scale counterclockwise value (within tolerance) with the increase and next keys. Press the save key.

10. The display will now read “CW CAL0”. This means the meter is ready to read the clockwise zero reading. Load the transducer, with a balanced arm and slight pre-load, in the clockwise direction three times to full scale with dead weights, and remove the weights but not the arm and pre-load. Wait 30 seconds or for the hanger to settle and press the Zero buttons (even if the display shows 000.0).

The display will now show “CW FS” which means load the arm to full scale in the clockwise direction. Press the save key.

Make the display read as close as possible to the full scale clockwise value by pressing the increase and next keys.

Press the save key.

You will now exit and be in the track mode with the display reading the calibrated full scale clockwise value. The calibration data you just created will be saved in the memory of the meter, under the custom transducer number you assigned to that transducer.

From now on, if you want to use the manual calibration values that you just entered you simply need to select the proper transducer number when selecting custom transducers. you do not have to re-select a smart transducer custom assigned number unless you have disconnected the transducer from the meter.

You can repeat the above process adjusting the full scale value until the unit reads as accurately as you desire at any point on the scale.

### **Selecting custom transducers:**

If you have a non-smart custom transducer that you have calibrated manually, per the above procedure, the meter will automatically recognize that the attached transducer is not smart and prompt you with a transducer number every time you turn on the meter. Simply press the next key to select the proper transducer number, then press save and you will enter the normal operation mode. The meter will always turn on with this transducer number active (on non-smart transducers) and will use the calibration data that was entered during the manual calibration process.

If you have a smart transducer and have also assigned it a custom transducer number you do not have to re-select the custom number as long as you do not detach the transducer (even after power down). If you have detached the transducer then the meter will re-read the smart chip and use the smart data, not the custom data, when it is turned on. Select the custom transducer in this case. Do this by pressing the transducer keys and pressing the next key until the display shows the transducer number you have assigned to the transducer. Press the save key and the unit will now use the calibration data that was stored in the memory of the meter for that transducer. Remember, you only have to select the custom transducer number after you have detached the transducer.

### **Printing and Sending Data**

Note:

It is not within the scope of this manual to instruct the user on how to set his/her computer or printer up for data transfer. Please refer to the operation manual of your particular printer or computer.

The torque meter operates with an industry standard RS232C communication port. You can use a program as simple as “Hyper terminal” that comes standard with Windows or any third party data logging software.

The torque meter sends data as follows:

RS232C, 4800, 8, 1, n

Refer to your computer or printer operation manual for a description of these settings.

The torque meter will send data out the communication port under the following circumstances:

When the save key is pressed the data on the display will be sent (and saved).

When the “send mem” function is selected, from the menu function, it will send all the

data in memory.

When the recall key is pressed and held for 1 second the torque meter will send the torque value on the display.

### **Battery and Power**

The torque meter uses either a common 9 volt battery (gives longest life) or a rechargeable 9 volt battery (supplied standard for convenience).

Battery life depends significantly on the type of battery used. Non-rechargeable lithium ion 9-volt batteries may last up to 40 hours. Common alkaline batteries may last up to 20 hours.

It is recommended that if you are going to use the meter on battery power that you keep a standard 9 volt battery as a backup, or an additional charged 9 volt battery. Any common re-chargeable 9 volt battery can be used in the torque meter.

The Torque meter has a power down (standby) mode that will activate after approximately 3 minutes without use. This mode still uses battery power.

Press the clear key to resume operation when the power down mode is active (depicted by "...” on the display). The sleep mode still takes power so if you are on battery power it is best to turn the meter off when not in use, this will result in longest battery life.

The torque meter will show a "B" icon on the display when the battery is low and will show a "B" with two dashes "- -" on the main digits when the batteries are critically low.

The time between low battery and critically low battery may vary depending on the state and type of battery.

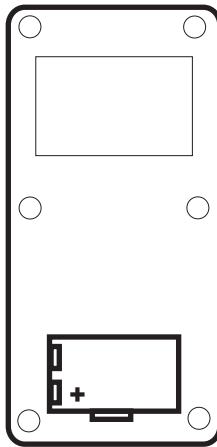

Make sure battery is placed with + side as shown

The torque meter can be used while the batteries are charging with no adverse effect. The supplied power adapter is a trickle charger that will take at least 14 hours to charge a 9 volt battery. You can use any standard external quick charger to charge the 9 volt battery.

## Specifications

|                                      |  |
|--------------------------------------|--|
| Range and Display:                   | Direct reading triple numeric LCD display with large 4 digit primary display (5/8" high) and two additional 4 digit displays. Maximum reading 9999. Floating Decimal Point.  |
| Accuracy :                           | When used with:<br>Smart Bench top: .5% IV from 10 – 100 % of transducer range +/- .1.<br>Smart Extension: 1% IV from 10 – 100% of transducer range +/- .1.<br>Greater accuracy may be achieved with manual calibration. |
| Sampling Rate:                       | Approx. 8,000 samples per second.  |
| Power:                               | Battery: common 9 volt - ( rechargeable NiCd supplied for convenience).  |
| Battery life:                        | Up to 20 hours with standard 9 volt battery under normal use*.   |
| Recharging Circuit:                  | Internal. 110 volt input, 9 volt 300 mA output, adapter supplied standard (center positive 2.1 mm connector).  |
| Meter Case:                          | Dimensions: 7.25" long x 3.25 " wide x 1.25" thick.<br>Weight: Less than 8 ounces  |
| Stand:                               | Folding and adjustable bench, wall or shelf stand supplied standard.   |
| Memory:                              | Up to 1,350 torque data. Includes data number, torque value and units.   |
| Communication:                       | Direct to serial computer or printer.<br>RS232C 4800 BPS, 8, 1, n.<br>Communication cable and adapter supplied standard.   |
| Operating Modes:<br>torque wrenches. | Track, Peak and First Peak for calibration of Micrometer (clicking)  |
| Limits setting:                      | Tolerance values displayed on triple numeric display during operation.<br>Quick on/off with one key.<br>User selectable % (1-99%) with programmable target.<br>or<br>Programmable high and low values.                   |
| Tolerance prompting:                 | Triple lights and buzzer: Yellow (under), Green (within), Red (over)<br>Tolerance values displayed on triple numeric display during operation.   |
| Display Clear Modes:                 | Automatic cycle complete.<br>Programmable timed auto reset from 1 – 9 seconds.<br>Manual Clear.  |
| Filters:                             | 5 user selectable filter settings: 170hz, 250 Hz, 500 Hz, 1500 Hz, 3600 Hz.  |
| Transducer Selection:                | Automatic "plug and play" with smart chip.<br>or manual "custom calibration".  |

\* Battery life will vary depending on quality of battery and usage-values estimates only. Longest life will come from a lithium ion 9 volt battery.